



## Vee

Design by Q Design

With Vee, Allermuir has produced a solution that allows individuality and collaboration to happily coexist. With its simplistic, inviting form, complemented by full, sound absorbing upholstery, as well as integrated power and under seat storage,

Vee is ideally suited for quick touchdowns and recharges, or longer work meetings.

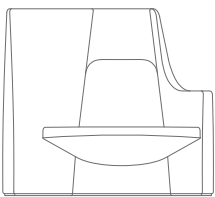

VE01LH

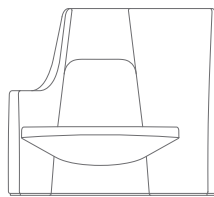

VE01RH

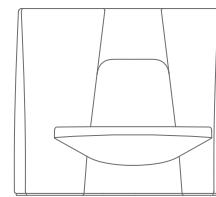

VE02LH

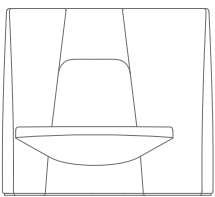

VE02RH

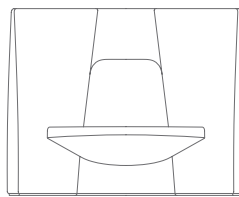

VE03



VE05FS



VEBC



## Design Q Design

Q Design was launched as Quicksilver in 1994. After quickly finding themselves in the spotlight of the contract furniture industry, Q Design has evolved into an edgy, one-stop-shop for product development. With their intellectual partners, they are not only able to design award-

winning furniture and products but also assist in revitalizing client's images, communication, and distribution to keep up with the industry's ever-changing standards.

## Standard Features

(\* - Selected models only)

Traditional carcass construction

Fully upholstered

Plastic glides

Two-tone configuration as standard (outer back in one fabric, seat and inner back in second fabric)\*

## Optional Features

Plastic glides with felt

Integrated power\*

## Dimensions

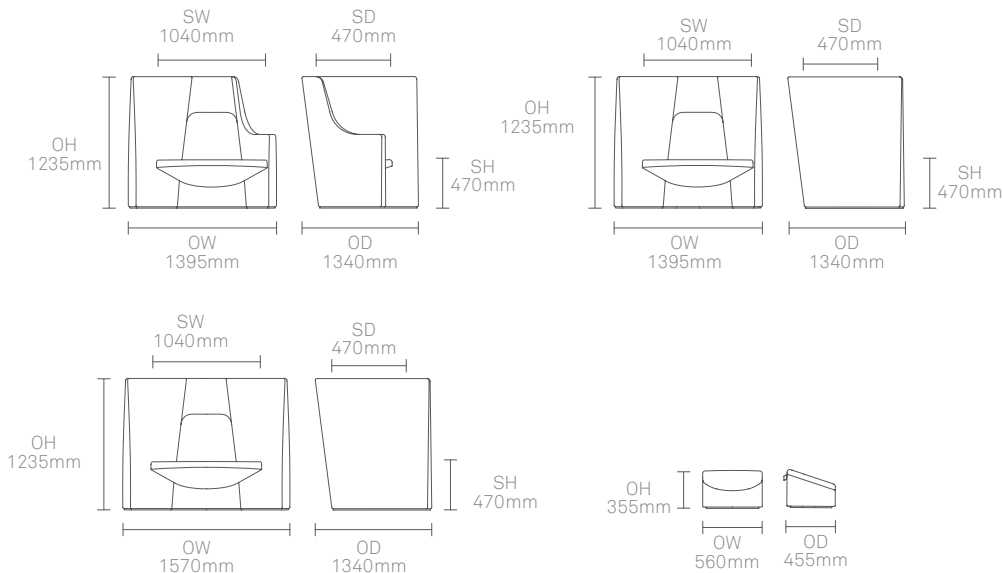

## Environmental Performance

### Material Content

Components are constructed of the following

### Recycled Content

Contains up to 12.5% of Recycled Material

### Recyclability

The range is 100% recyclable

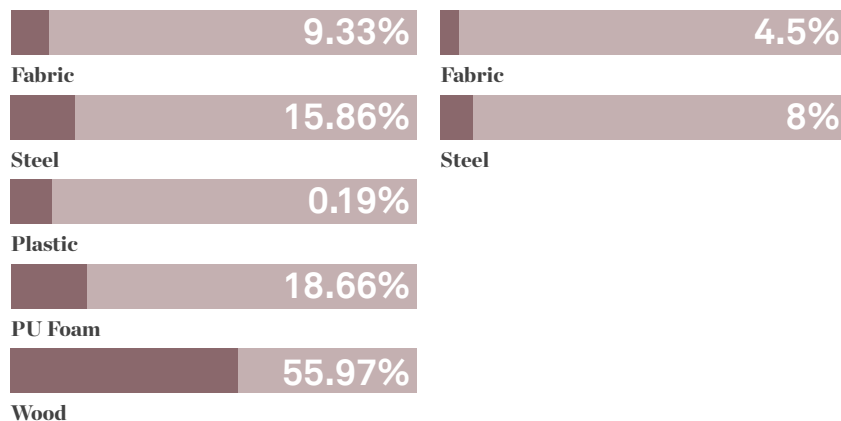

# 100%

## Finish Options

Vee can be upholstered in a broad range of contract upholstery fabrics and leathers from the standard Allermuir upholstery collection\*