



Henge

Design by Q Design

Henge is a modern interpretation of the classic club and tuxedo lounge chair, a hybrid of organic yet tailored shapes, with wedge shape seating that allows endless configurations for any space.

The unique two-tone upholstery detail adds a sophisticated design element, while the separate seat cushion can be upholstered in complementary or contrasting textiles, enhancing the longevity of the design.

Models

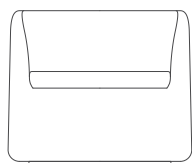

HNG102

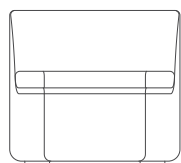

HNG100CAV

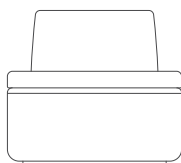

HNG100VEX

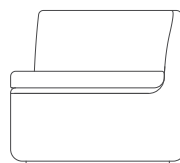

HNG101LH

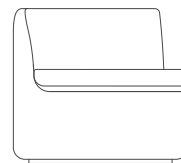

HNG101RH

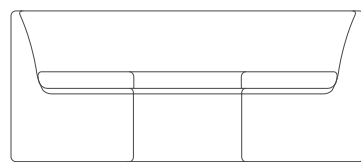

HNG105

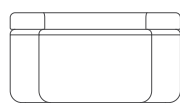

HNG104CAV

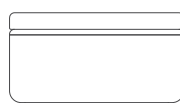

HNG104VEX



Design by Q Design

Q Design was launched as Quicksilver in 1994. After quickly finding themselves in the spotlight of the contract furniture industry, Q Design has evolved into an edgy, one-stop-shop for product development. With their intellectual partners, they are not only able to design award-winning furniture and

products but also assist in revitalizing client's images, communication, and distribution to keep up with the industry's ever-changing standards.



Standard Features

- Traditional carcass construction
- Fully upholstered
- Tensioned seat support
- Seat to seat linking*
- Swivel base
- Plastic glides*

Optional Features

- Memory return base
- Two-tone upholstery

* Select models only

Dimensions

OH - Overall Height OD - Overall Depth OW - Overall Width AH - Arm Height SH - Seat Height SW - Seat Width SD - Seat Depth

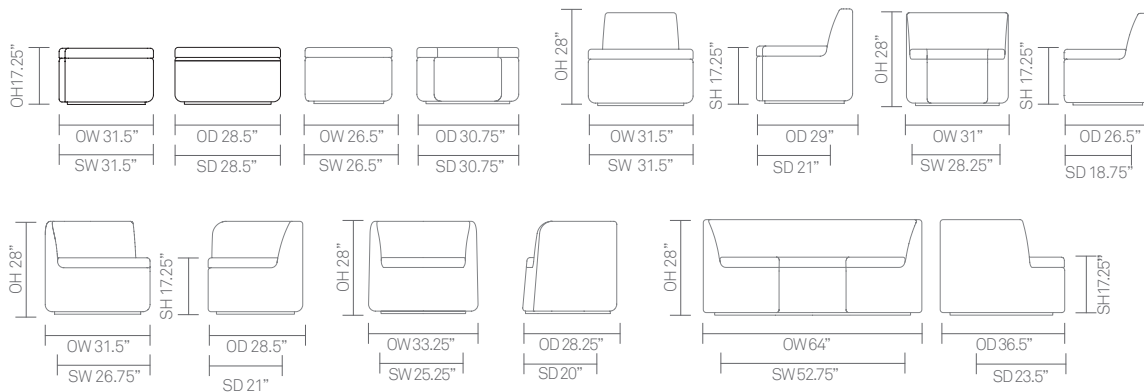

Environmental Performance

Components are constructed of the following



Steel



PU Foam



Steel



MDF



Fabric

Contains up to 14.00% of Recycled Material



Steel



MDF



Fabric

The range is 99% recyclable

99%



Finish Options

- Henge can be upholstered in a select range of contract upholstery fabrics from Allermuir's standard upholstery collection

* Select models only